

PART NO.	MAST DIAMETER	WEIGHT
UR-237X8	2.37"OD	222 lbs.
UR-288X8	2.88"OD	241 lbs.
UR-450X8	4.50"OD	284 lbs.

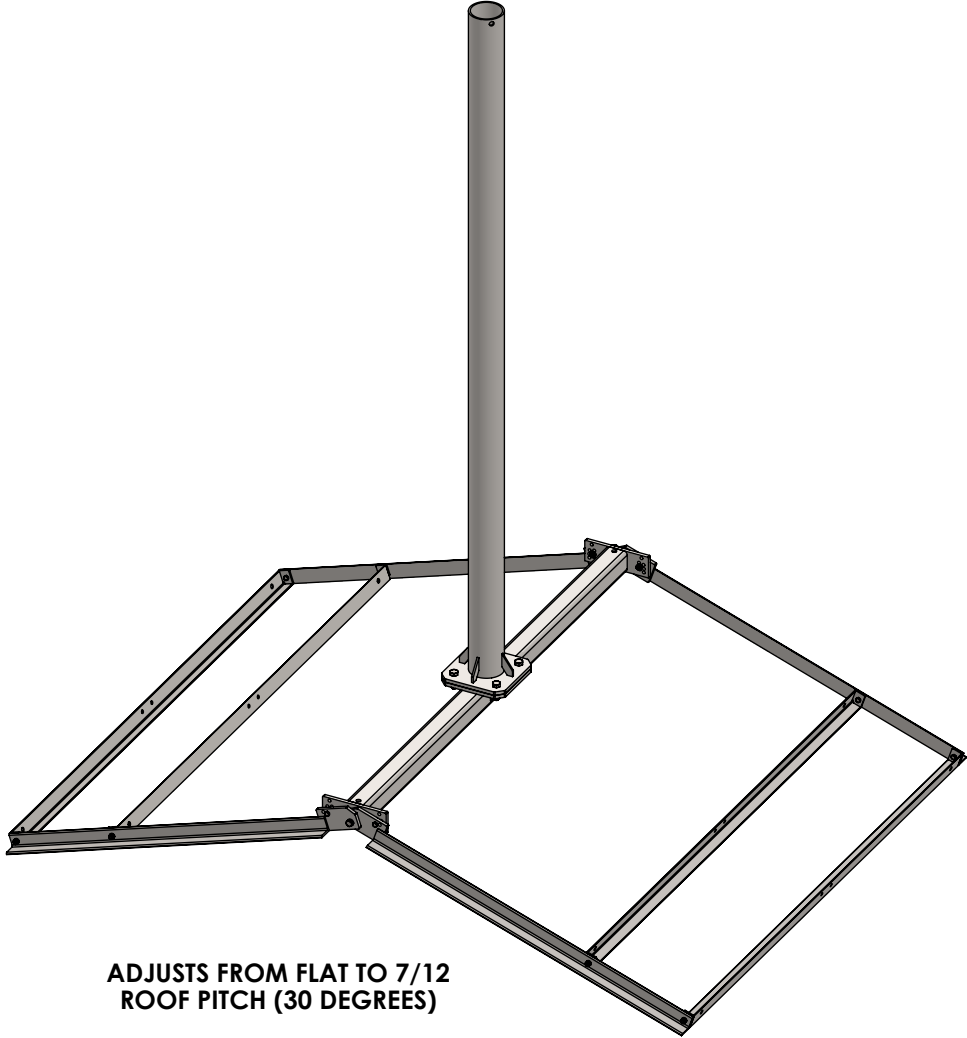

**ADJUSTS FROM FLAT TO 7/12
ROOF PITCH (30 DEGREES)**

PROPRIETARY AND CONFIDENTIAL
THE INFORMATION CONTAINED IN THIS DRAWING IS THE SOLE PROPERTY OF BAIRD SUPPORTING SYSTEMS. ANY REPRODUCTION IN PART OR AS A WHOLE WITHOUT THE WRITTEN PERMISSION OF BAIRD SUPPORTING SYSTEMS IS PROHIBITED.



WWW.BAIRD MOUNTS.COM

UNLESS OTHERWISE SPECIFIED:
DIMENSIONS ARE IN INCHES
TOLERANCES:
FRACTIONAL ±
ANGULAR: MACH ± BEND ±
TWO PLACE DECIMAL ±
THREE PLACE DECIMAL ±

DO NOT SCALE DRAWING

BAIRD MOUNTING SYSTEMS

WATERLOO, IA 50703
PHONE: 319-233-3561
SALES@BAIRDMOUNTS.COM

DESCRIPTION:
UNIVERSAL RIDGEMOUNT (UR) WITH 8' MAST

DRAWN BY JK	DATE 06/15/13
MATERIAL STEEL	FINISH HDG
DWG. PURPOSE CUSTOMER	SHEET 1OF2
SCALE -	
PART. NO. SEE TABLE	
DWG. NO. UR-(000)X8	

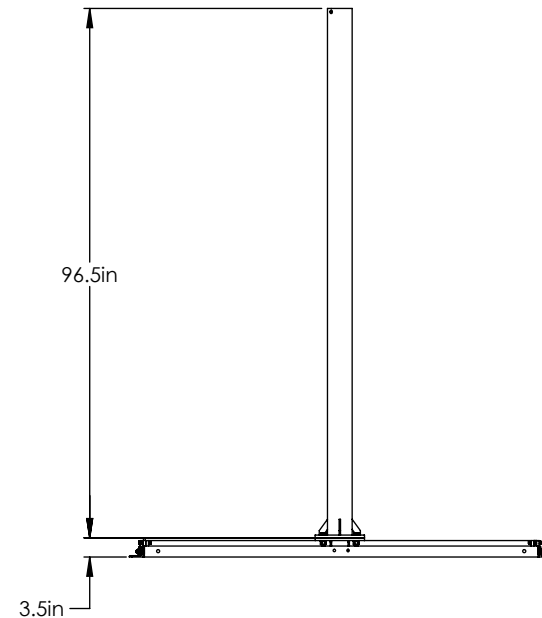
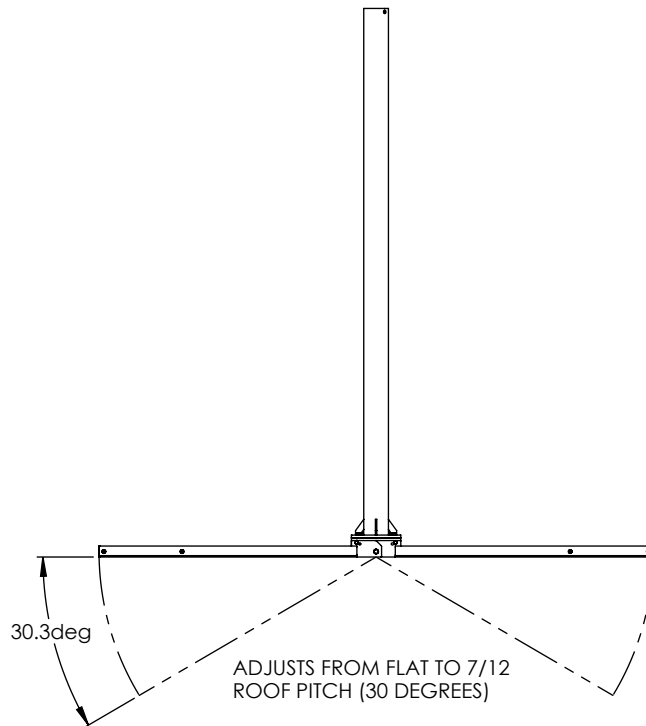
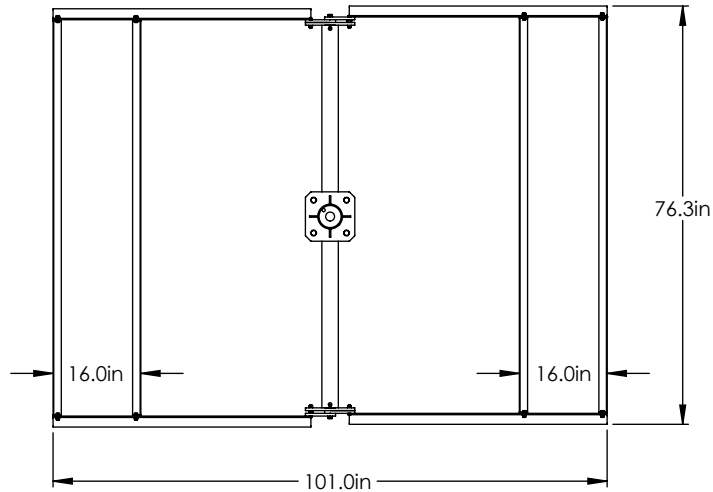

PROPRIETARY AND CONFIDENTIAL
 THE INFORMATION CONTAINED IN THIS DRAWING IS THE SOLE PROPERTY OF BAIRD SUPPORTING SYSTEMS. ANY REPRODUCTION IN PART OR AS A WHOLE WITHOUT THE WRITTEN PERMISSION OF BAIRD SUPPORTING SYSTEMS IS PROHIBITED.



WWW.BAIRD MOUNTS.COM

UNLESS OTHERWISE SPECIFIED:
 DIMENSIONS ARE IN INCHES
 TOLERANCES:
 FRACTIONAL ±
 ANGULAR: MACH ± BEND ±
 TWO PLACE DECIMAL ±
 THREE PLACE DECIMAL ±

DO NOT SCALE DRAWING

BAIRD MOUNTING SYSTEMS

WATERLOO, IA 50703
 PHONE: 319-233-3561
 SALES@BAIRD MOUNTS.COM

DESCRIPTION:
 UNIVERSAL RIDGEMOUNT (UR) WITH 8' MAST

DRAWN BY JK	DATE 06/15/13	
MATERIAL STEEL	FINISH HDG	
DWG. PURPOSE CUSTOMER	SHEET 2 OF 2	SCALE -
PART. NO. SEE TABLE- SHEET 1		
DWG. NO. UR-(000)X8		