

PART NO.	MAST DIAMETER	WEIGHT
UR-237X10	2.37"OD	230lbs.
UR-288X10	2.88"OD	253 lbs.
UR-450X10	4.50"OD	307 lbs.



**ADJUSTS FROM FLAT TO 7/12
ROOF PITCH (30 DEGREES)**

PROPRIETARY AND CONFIDENTIAL
THE INFORMATION CONTAINED IN THIS DRAWING IS THE SOLE PROPERTY OF BAIRD SUPPORTING SYSTEMS. ANY REPRODUCTION IN PART OR AS A WHOLE WITHOUT THE WRITTEN PERMISSION OF BAIRD SUPPORTING SYSTEMS IS PROHIBITED.



WWW.BAIRD MOUNTS.COM

UNLESS OTHERWISE SPECIFIED:
DIMENSIONS ARE IN INCHES
TOLERANCES:
FRACTIONAL ±
ANGULAR: MACH ± BEND ±
TWO PLACE DECIMAL ±
THREE PLACE DECIMAL ±

DO NOT SCALE DRAWING

BAIRD MOUNTING SYSTEMS

WATERLOO, IA 50703
PHONE: 319-233-3561
SALES@BAIRDMOUNTS.COM

DESCRIPTION:
UNIVERSAL RIDGEMOUNT (UR) WITH 10' MAST

DRAWN BY JK	DATE 06/15/13	
MATERIAL STEEL	FINISH HDG	
DWG. PURPOSE CUSTOMER	SHEET 1OF2	SCALE -
PART. NO. SEE TABLE		
DWG. NO. UR-(000)X10		

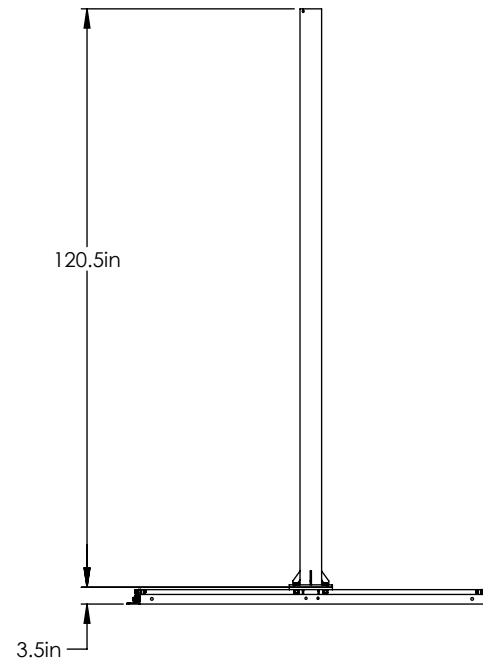
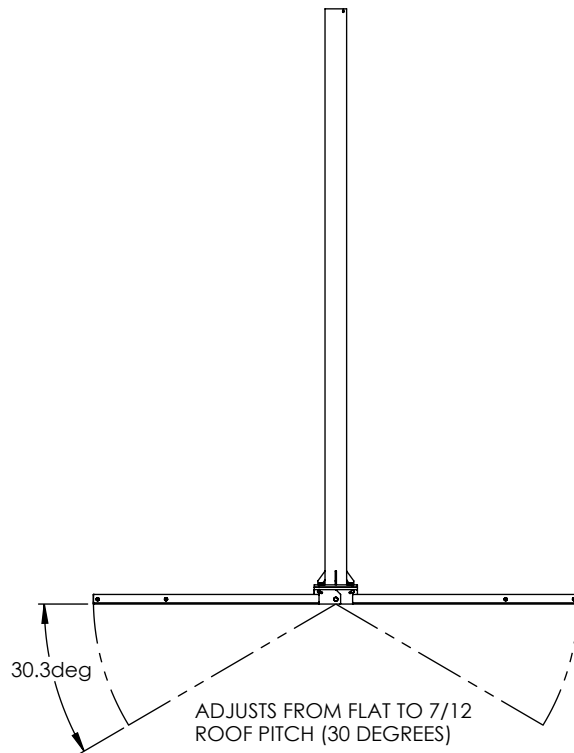
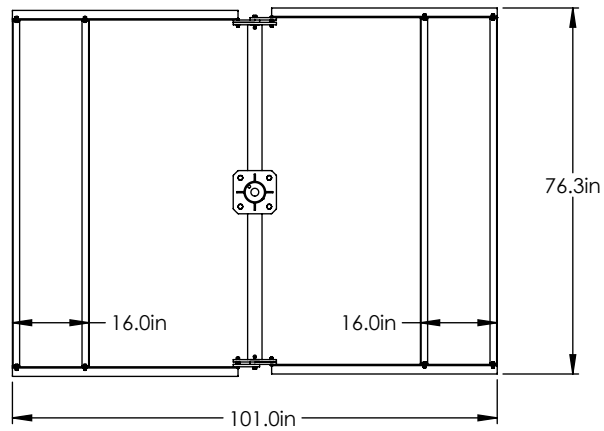

PROPRIETARY AND CONFIDENTIAL

THE INFORMATION CONTAINED IN THIS DRAWING IS THE SOLE PROPERTY OF BAIRD SUPPORTING SYSTEMS. ANY REPRODUCTION IN PART OR AS A WHOLE WITHOUT THE WRITTEN PERMISSION OF BAIRD SUPPORTING SYSTEMS IS PROHIBITED.



WWW.BAIRD MOUNTS.COM

UNLESS OTHERWISE SPECIFIED:

DIMENSIONS ARE IN INCHES
TOLERANCES:
FRACTIONAL ±
ANGULAR: MACH ± BEND ±
TWO PLACE DECIMAL ±
THREE PLACE DECIMAL ±

DO NOT SCALE DRAWING

BAIRD MOUNTING SYSTEMS

WATERLOO, IA 50703
PHONE: 319-233-3561
SALES@BAIRD MOUNTS.COM

DESCRIPTION:

UNIVERSAL RIDGEMOUNT (UR) WITH 10' MAST

DRAWN BY JK	DATE 06/15/13	
MATERIAL STEEL	FINISH HDG	
DWG. PURPOSE CUSTOMER	SHEET 2 OF 2	SCALE -
PART. NO. SEE TABLE- SHEET 1		
DWG. NO. UR-(000)X10		