

PART NO.	MAST DIAMETER	WEIGHT
B44DRB-237X8	2.37"OD	87 lbs.
B44DRB-288X8	2.88"OD	105 lbs.

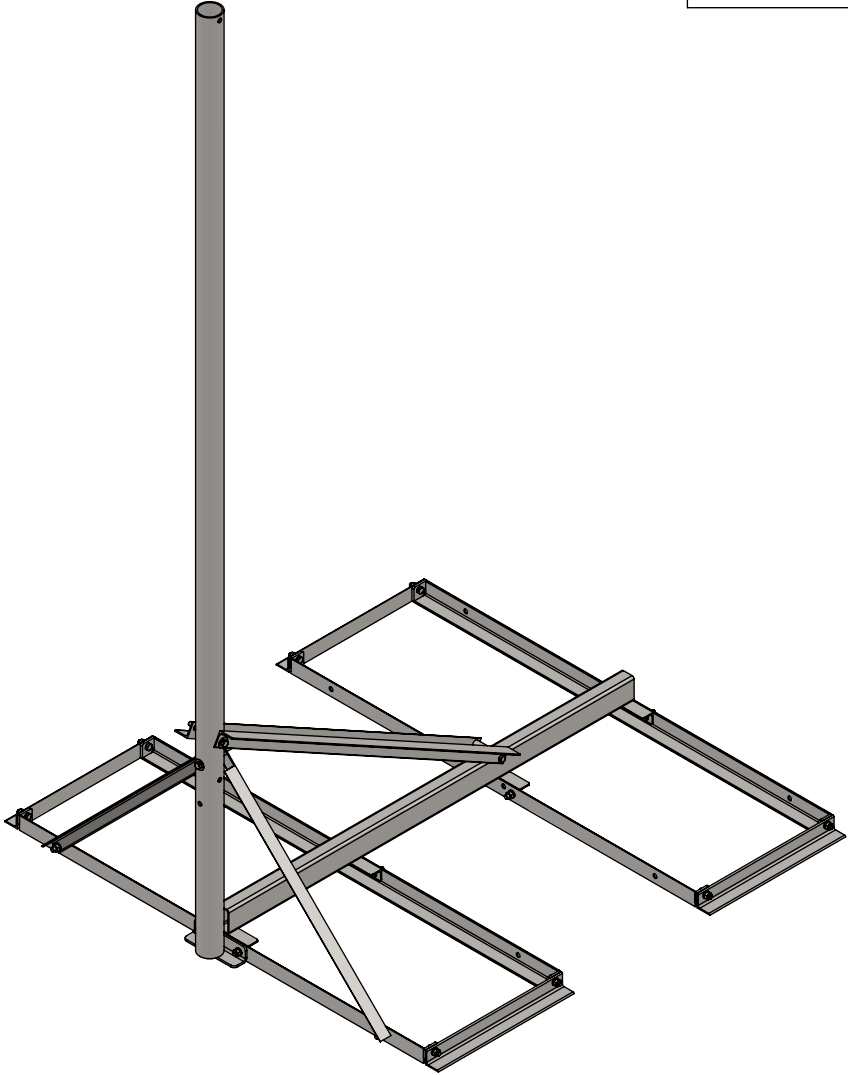

PROPRIETARY AND CONFIDENTIAL
 THE INFORMATION CONTAINED IN THIS DRAWING IS THE SOLE PROPERTY OF BAIRD SUPPORTING SYSTEMS. ANY REPRODUCTION IN PART OR AS A WHOLE WITHOUT THE WRITTEN PERMISSION OF BAIRD SUPPORTING SYSTEMS IS PROHIBITED.



WWW.BAIRD MOUNTS.COM

UNLESS OTHERWISE SPECIFIED:
 DIMENSIONS ARE IN INCHES
 TOLERANCES:
 FRACTIONAL ±
 ANGULAR: MACH ± BEND ±
 TWO PLACE DECIMAL ±
 THREE PLACE DECIMAL ±

DO NOT SCALE DRAWING

BAIRD MOUNTING SYSTEMS

WATERLOO, IA 50703
 PHONE: 319-233-3561
 SALES@BAIRD MOUNTS.COM

DESCRIPTION:
 B4-4X4DRB MOUNT WITH 8' MAST

DRAWN BY JK	DATE 08/02/18	
MATERIAL STEEL	FINISH HDG	
DWG. PURPOSE CUSTOMER	SHEET 1 OF 2	SCALE -
PART. NO. SEE TABLE		
DWG. NO. B44DRB-(000)X8		

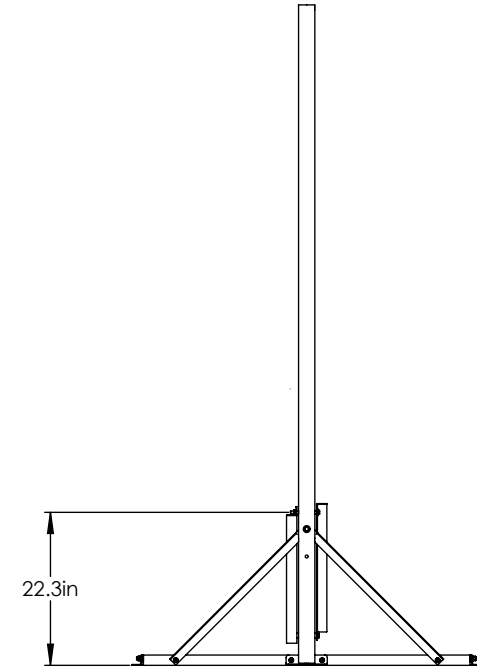
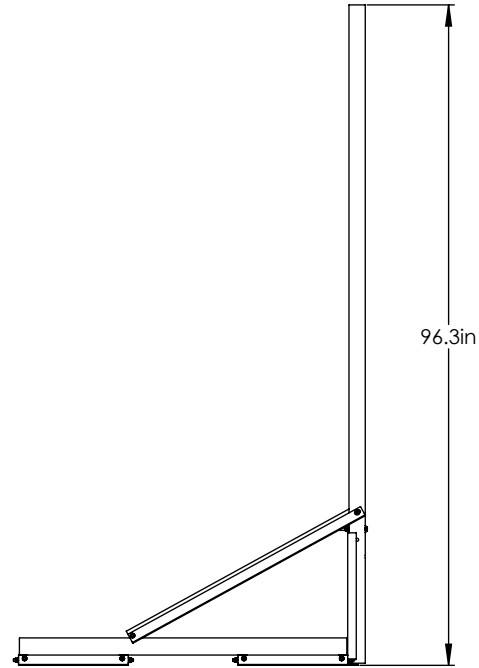
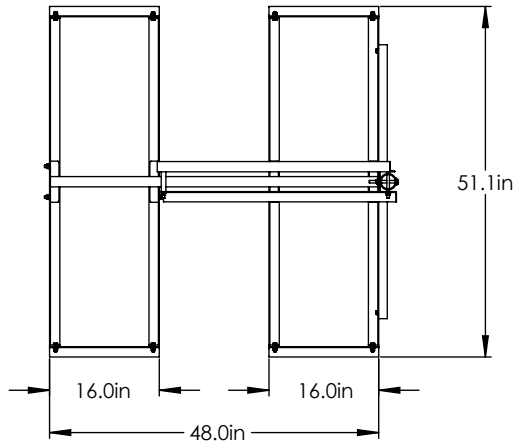

PROPRIETARY AND CONFIDENTIAL
 THE INFORMATION CONTAINED IN THIS DRAWING IS THE SOLE PROPERTY OF BAIRD SUPPORTING SYSTEMS. ANY REPRODUCTION IN PART OR AS A WHOLE WITHOUT THE WRITTEN PERMISSION OF BAIRD SUPPORTING SYSTEMS IS PROHIBITED.



WWW.BAIRD MOUNTS.COM

UNLESS OTHERWISE SPECIFIED:
 DIMENSIONS ARE IN INCHES
 TOLERANCES:
 FRACTIONAL ±
 ANGULAR: MACH ± BEND ±
 TWO PLACE DECIMAL ±
 THREE PLACE DECIMAL ±

DO NOT SCALE DRAWING

BAIRD MOUNTING SYSTEMS

WATERLOO, IA 50703
 PHONE: 319-233-3561
 SALES@BAIRD MOUNTS.COM

TITLE:
 B4-4X4DRB MOUNT WITH 8' MAST

DRAWN BY JK	DATE 08/02/18
MATERIAL STEEL	FINISH HDG
DWG. PURPOSE CUSTOMER	SHEET 2OF2
	SCALE -

PART. NO.
 SEE TABLE-SHEET 1

DWG. NO.
 B44DRB-(000)X8